

## Low Noise Type Solenoid Control Relief Valve

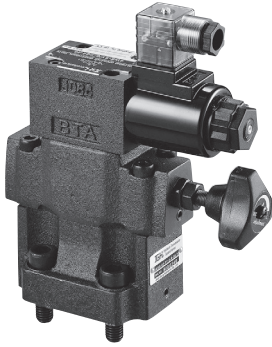

閥類型符號 SYMBOL  
SBSG- ※

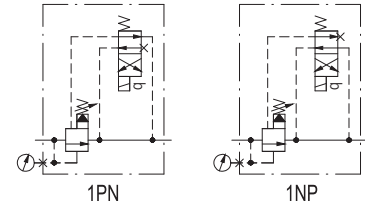

### 規格說明

### SPECIFICATION

型式 MODEL	最高使用壓力 MAX. OPERATING PRESSURE (kgf/cm <sup>2</sup> )	調壓範圍 PRESSURE ADJ. RANGE kgf/cm <sup>2</sup>	最大流量 MAX. FLOW L/min	重量 (不含電磁閥) WEIGHT (NO CONTAIN SOLENOID VALVE) kg
SBSG-03	250	0 : 7-35	100	4.1
SBSG-06		1 : 7-70	200	5.1
SBSG-10		2 : 7-140 3 : 7-210	400	6.5

### 型號說明

### HOW TO ORDER

**SBS G-06-1PN-3-R-30-10-W220/50-20-40**

電磁閥型式 SOLENOID TYPE

接線方式 WIRING

10 : 帶燈的集中連接盒  
WITH LAMP CENTRAL CONNECTION  
20 : 插入式接頭帶密封套  
PLUG-IN CONNECTION

線圈電壓 COIL VOLTAGE

G12 : 12V DC      G24 : 24V DC  
W110 : 110/50/60Hz      W220 : 220/50/60Hz

設計編號 DESIGN NUMBER

調桿型式 ADJUSTMENT TYPE

30 : 標準型 STANDARD TYPE  
32 : T型推環直結式  
THRUST RING LINK TYPE

把手方向 DIRECTION OF KNOB

R : 右(P口側標準型)  
RIGHT (P PORT SIDE STANDARD)  
L : 左(T口側) LEFT (T PORT SIDE)

調壓範圍 PRESSURE ADJUSTING RANGE

0 : 7-35 kgf/cm<sup>2</sup>      1 : 7-70 kgf/cm<sup>2</sup>  
2 : 7-140 kgf/cm<sup>2</sup>      3 : 7-210 kgf/cm<sup>2</sup>

閥型式 VALVE TYPE

1PN : 常開 NORMALLY VENTED  
1NP : 常閉 ENERGIZED TO VENT

閥規格 VALVE SIZE

03 : 3/8"      06 : 3/4"      10 : 1-1/4"

安裝型式 MOUNTING

G : 板式安裝 SUB-PLATE MOUNTING

系列編號 SERIES NUMBER

### 附屬品 ATTACHMENT

型式 MODEL	安裝螺絲 SOC HOL CAP SCREW	安裝扭矩 MOUNTING TORQUE N·m	4WE-06電磁閥重量 SOLENOID WEIGHT (kg)	
<b>SBSG-03</b>	M12 x 40L...4pcs	104~127		
<b>SBSG-06</b>	M16 x 50L...4pcs	253~310		
<b>SBSG-10</b>	M20 x 65L...4pcs	493~603		
			AC	DC
			帶1個電磁鐵 Single coil	1.6 1.7
			帶2個電磁鐵 Two coils	2.1 2.1

### 測試條件 PERFORMANCE CURVES

測試油黏度 TEST FLUID VISCOSITY : 35cSt

測試油溫度 TEST TEMPERATURE : 50°C

#### ● SBG, SBSG-03

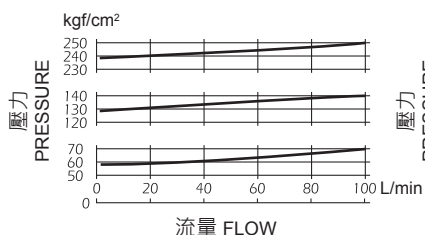

#### ● SBG, SBSG-06

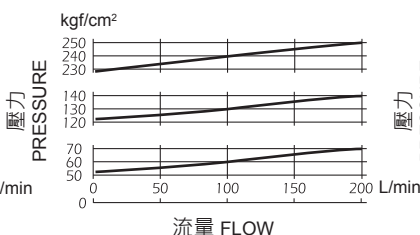

#### ● SBG, SBSG-10

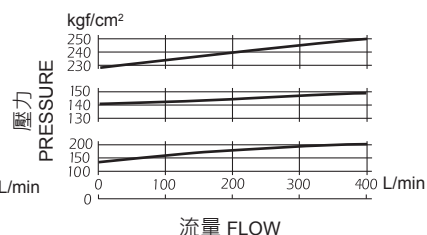

#### ● SBG, SBSG-03

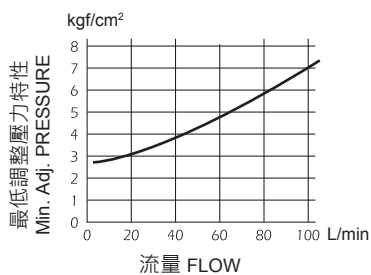

#### ● SBG, SBSG-06

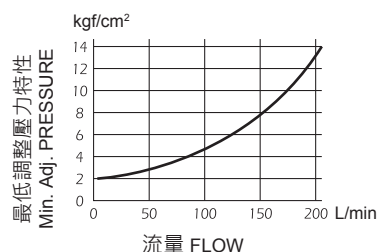

#### ● SBG, SBSG-10

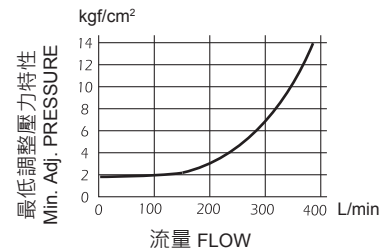

#### ● SBG, SBSG-03

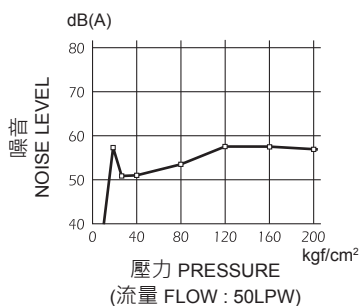

#### ● SBG, SBSG-06

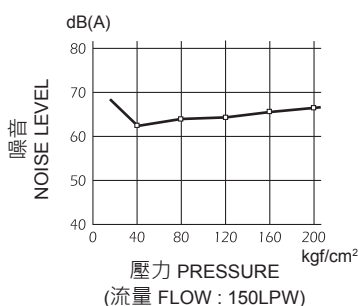

#### ● SBG, SBSG-10

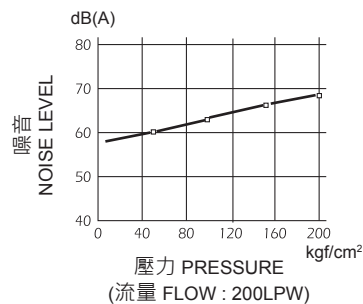

單位 UNIT : mm

**安裝尺寸** INSTALLATION DIMENSIONS

**SBSG-03~10-R..DC**

通用底板尺寸

APPLICATIVE

SUB-PLATE DIMENSIONS

**SBSG-03 ( MA - 02 - 1 )**

**SBSG-06 ( MA - 02 - 2 )**

**SBSG-10 ( MA - 02 - 3 )**

(詳見 E01-01 Page E01-01)

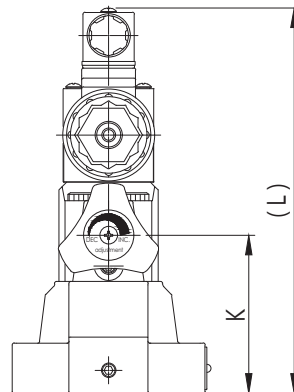
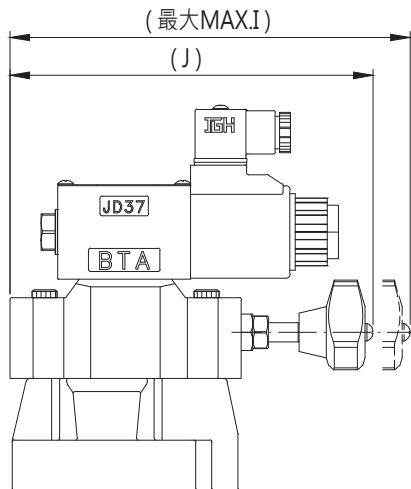
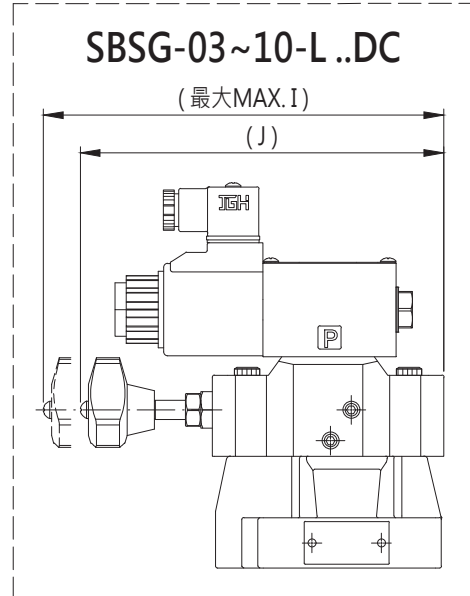
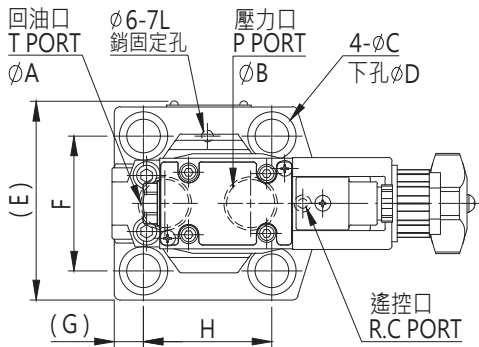

型式 MODEL	A	B	C	D	E	F
SBSG-03..DC	15	15	20	13	81	53.8
SBSG-06..DC	25	25	25	17.5	103	70
SBSG-10..DC	30	30	31.5	21.5	117	82.6

型式 MODEL	G	H	I	J	K	L
SBSG-03..DC	33.7	53.8	188.5	172.5	82	200
SBSG-06..DC	15	66.7	188.5	172.5	82	200
SBSG-10..DC	17	88.9	208.5	192.5	82	200