

Modular Reducing Valve

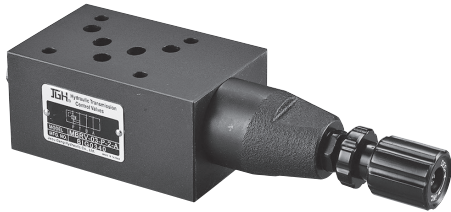

閥類型符號 SYMBOL
MBRV - ※

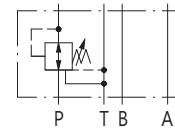

MBRV-※-P

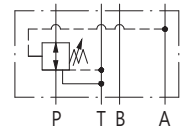

MBRV-※-A

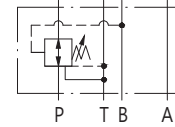

MBRV-※-B

規格說明 SPECIFICATION

| 型式 MODEL | 最高使用壓力 MAX. OPERATING PRESSURE kgf/cm ² | 調壓範圍 PRESSURE ADJ. RANGE kgf/cm ² | 最大流量 MAX. FLOW L/min | 重量 WEIGHT kg |
|-------------|--|--|----------------------------|--------------------|
| MBRV-02 | 250 | 0 : 3-40 1 : 7-70 2 : 7-140 3 : 7-210 | 35 | 1.3 |
| MBRV-03 | | | 70 | 3.5 |
| MBRV-04 | | | 190 | 7.0 |
| MBRV-06 | | | 300 | 11.6 |

型號說明 HOW TO ORDER

MBRV - 02 - P - 3 - A - L

旋轉型式 KNOB TYPE

無代號為K : 把手旋鈕螺桿調整(標準型)

NO CODE FOR K : HAFT TURNING KNOB BOLT ROD ADJUST (STANDARD TYPE)

L : 內六角螺桿調整

INNER HEXANGULAR BOLT ROD ADJUST

※ 調壓範圍3僅供L

PRESSURE RANGE 3 ONLY FOR L

把手方向 DIRECTION OF KNOB

A : A口側 A PORT SIDE

B : B口側(標準型) B PORT SIDE (STANDARD TYPE)

調壓範圍 PRESSURE ADJUSTING RANGE

0 : 3-40 kgf/cm²

1 : 7-70 kgf/cm²

2 : 7-140 kgf/cm²

3 : 7-210 kgf/cm²

控制油口 CONTROL OIL PORT

P : P口控制 P PORT

A : A口控制 A PORT

B : B口控制 B PORT

閥規格 VALVE SIZE

02 : 1/4"

03 : 3/8"

04 : 1/2"

06 : 3/4"

系列編號 SERIES NUMBER

測試條件 PERFORMANCE CURVES

測試油黏度 TEST FLUID VISCOSITY : 35cSt

測試油溫度 TEST TEMPERATURE : 50°C

● MBRV-02

壓力降特性 PRESSURE DROP

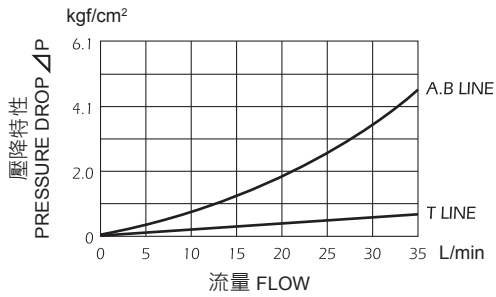

● MBRV-03

壓力降特性 PRESSURE DROP

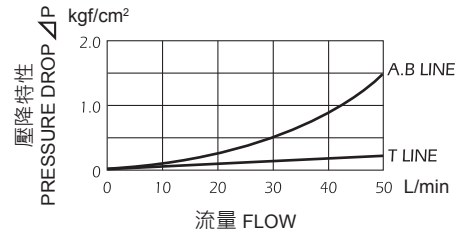

閥軸全開時壓力降特性 PRESSURE DROP AT SPOOL FULLY OPENED

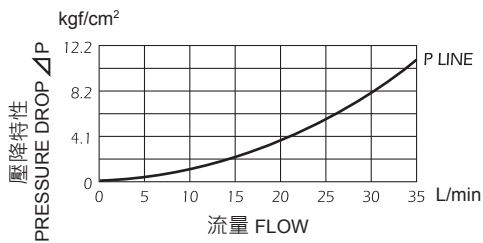

閥軸全開時壓力降特性 PRESSURE DROP AT SPOOL FULLY OPENED

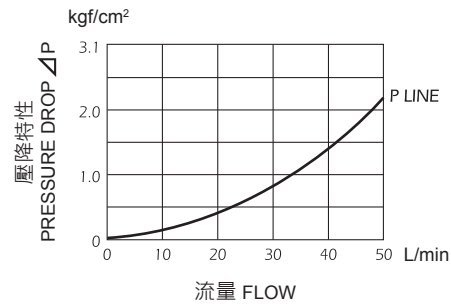

最低調整壓力-最大流量特性 Min.Adj. PRESSURE v.s. MAX. FLOW

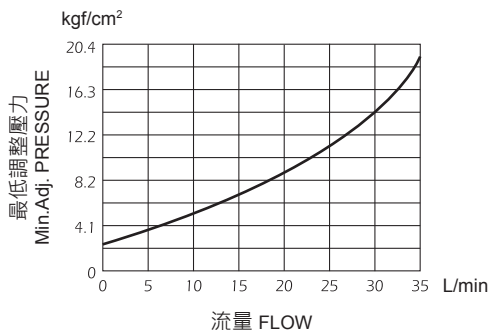

先導流量特性 PILOT FLOW

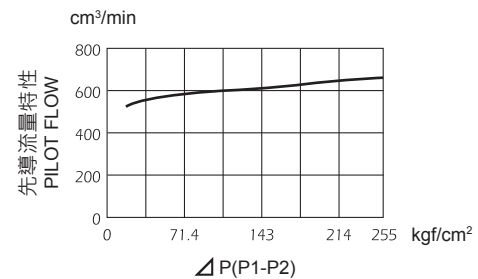

測試條件 PERFORMANCE CURVES

測試油黏度 TEST FLUID VISCOSITY : 35cSt

測試油溫度 TEST TEMPERATURE : 50°C

● MBRV-04

壓力降特性 PRESSURE DROP

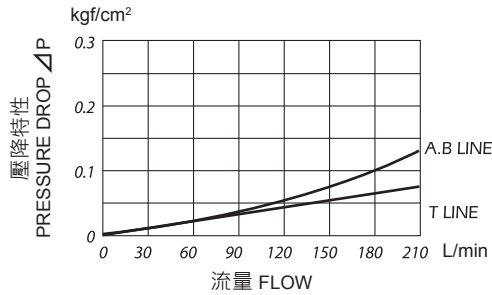

● MBRV-06

壓力降特性 PRESSURE DROP

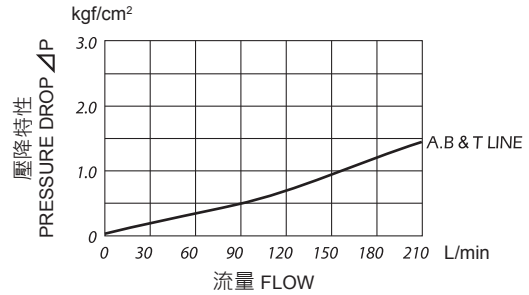

閥軸全開時壓力降特性
PRESSURE DROP AT SPOOL FULLY OPENED

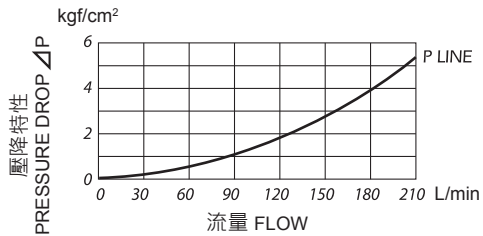

閥軸全開時壓力降特性
PRESSURE DROP AT SPOOL FULLY OPENED

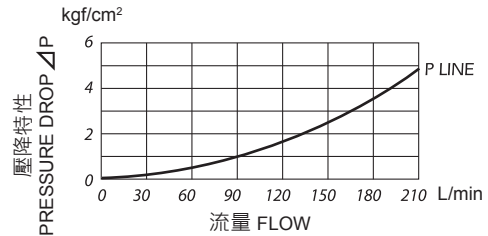

最低調整壓力-最大流量特性
Min.Adj. PRESSURE v.s. MAX. FLOW

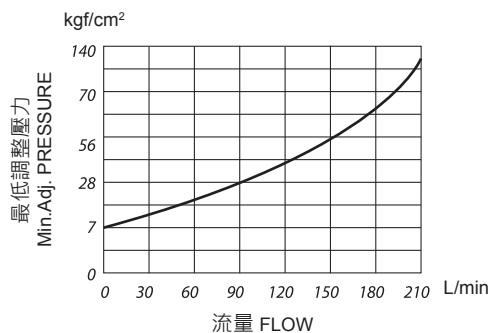

先導流量特性 PILOT FLOW

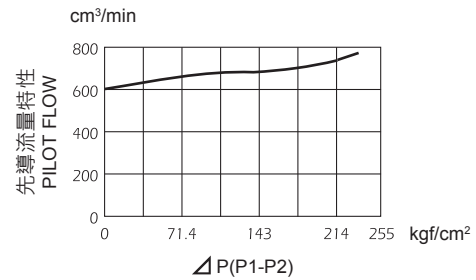

安裝尺寸 INSTALLATION DIMENSIONS

MBRV-02

MBRV-02-L

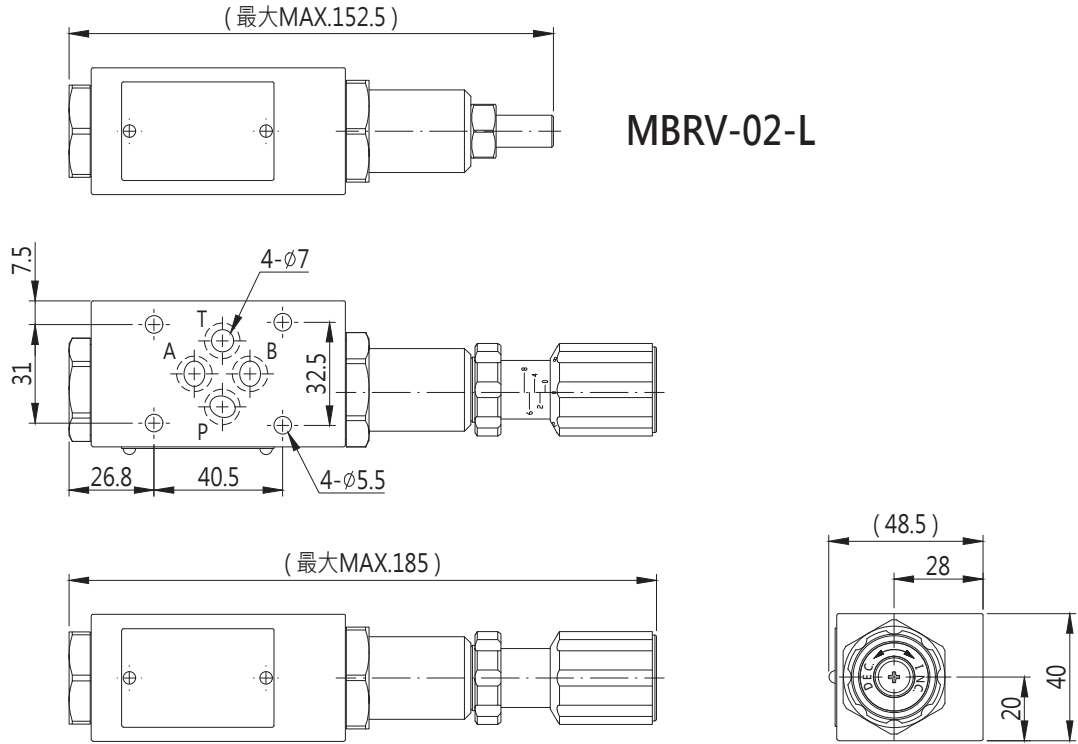

MBRV-03

MBRV-03-L

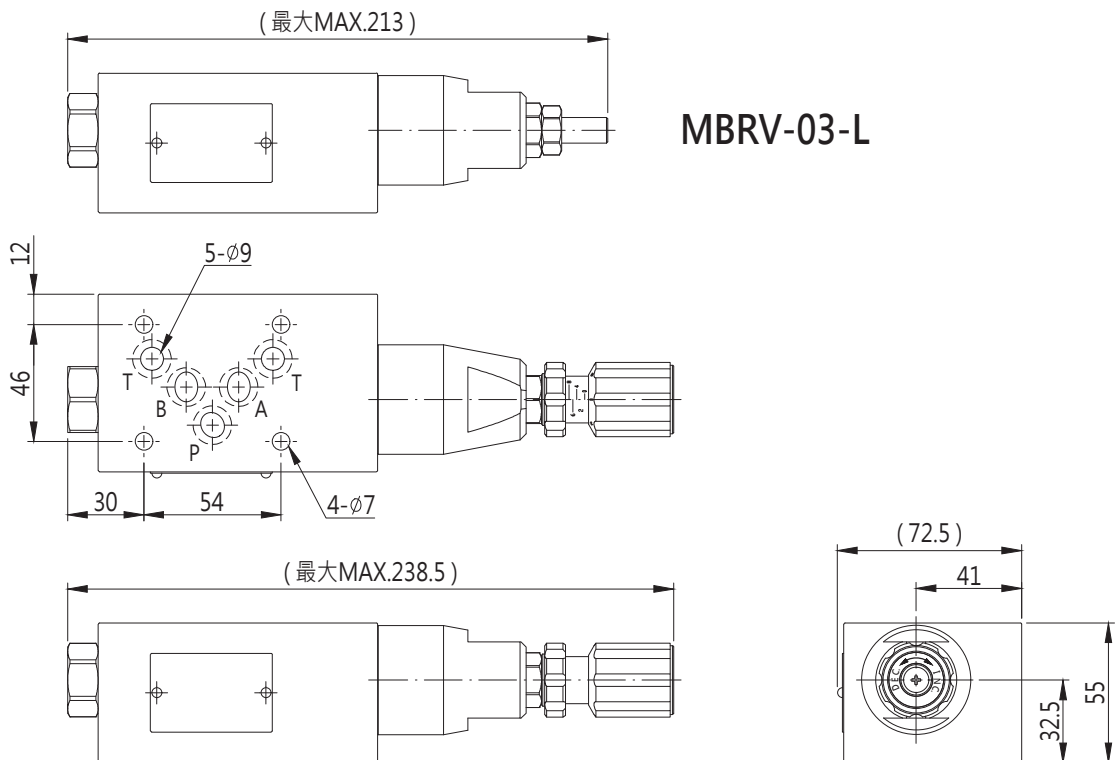

單位 UNIT : mm

安裝尺寸 INSTALLATION DIMENSIONS

MBRV-04

MBRV-04-L

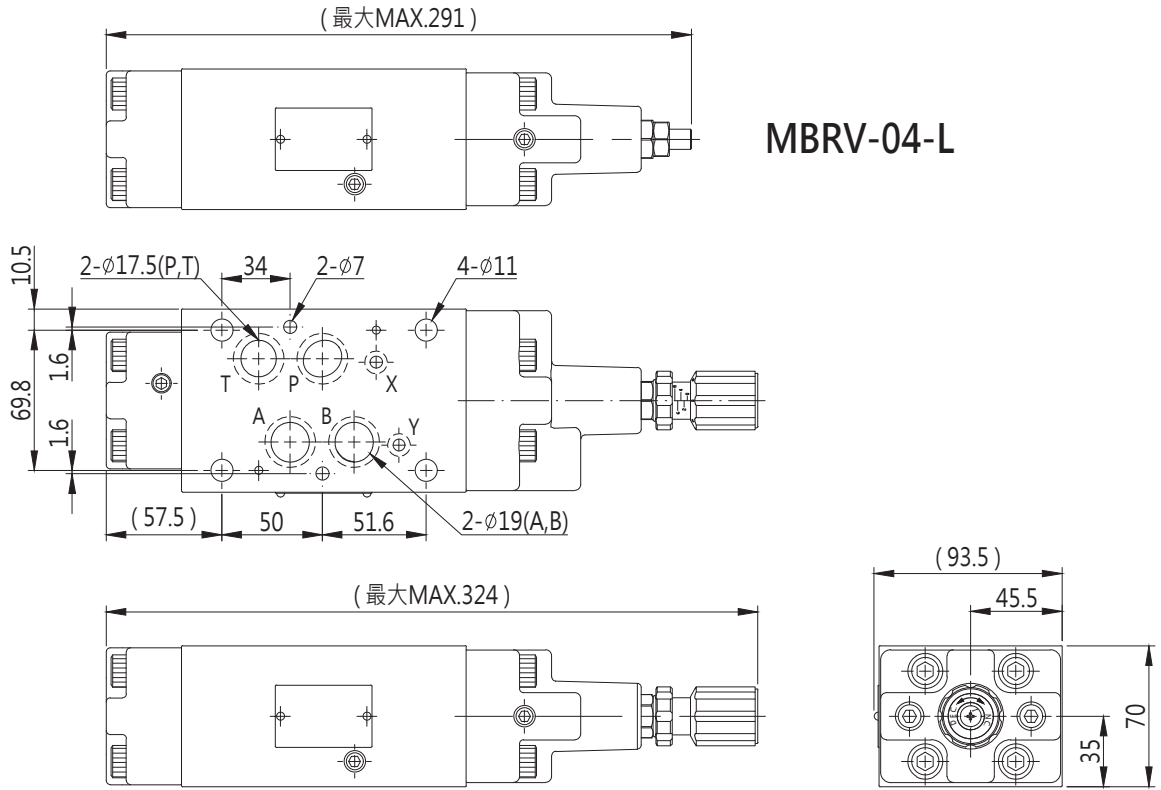

MBRV-06-A

