

## Solenoid Control Pilot Operated Directional Valve

### 特點 CHARACTERISTICS

- 此系統閥用於控制液流的開啟、停止和方向
- 電液操作(WEH) · 液壓(液控) (WH)
- 安裝面按DIN 24340 A型,ISO 4401 和 CETOP-RP 121 H
- 彈簧或壓力對中,彈簧或壓力復位
- 濕式直流或交流電磁鐵
- 可選的手動應急操作器
- Valve used to control the start, stop and direction of a fluid flow.
- Electro-hydraulic operation (WEH), hydraulic operation (WH)
- For subplates mounting,
- Porting pattern to DIN 24340 form A, ISO 4401 and CETOP-RP 121H
- Spring or pressure-centred, spring or hydraulic offset
- Wet-pin DC or AC solenoids, optional
- Manual override, optional



### 型號說明 HOW TO ORDER

**H - 4 WEH - 16 HE - ET / OE - W220/50 - 20 - 40**

電磁閥型式 SOLENOID TYPE

接線方式 WIRING

- 10 : 帶燈的集中連接盒  
WITH LAMP CENTRAL CONNECTION
- 20 : 插入式接頭帶密封套 PLUG-IN CONNECTION

線圈電壓 COIL VOLTAGE

- G12 : 12V DC
- G24 : 24V DC
- W110 : 110/50/60Hz
- W220 : 220/50/60Hz

E : 高性能電磁鐵 HIGH POWER SOLENOID

附可拆卸濕式線圈及電磁鐵  
WET PIN (OIL IMMERSED)  
WITH REMOVABLE COIL

無代號：彈簧復位 NO CODE : SPRING RETURN

O : 無彈簧復位 WITHOUT SPRING RETURN  
雙電磁鐵二位閥先導閥芯復位,僅對閥芯C、D、K、Z  
而言以及主閥中液壓閥芯復位  
SPOOL RETURN IN THE PILOT VALVE FOR 2-POSITION  
VALVE AND 2 SOLENOIDS  
ONLY POSSIBLE WITH SPOOLS C, D, K, Z  
AND HYDRAULIC SPOOL RETURN IN THE MAIN VALVE  
OF : 無彈簧帶定位機構 (在先導閥中)  
WITHOUT SPRING RETURN WITH DETENT  
(IN THE PILOT VALVE)

控油方式 PILOT AND DRAIN TYPE

無代號：內部引導內部洩油  
NO CODE : INTERNAL PILOT & DRAIN  
ET : 外部引導外部洩油 EXTERNAL PILOT & DRAIN  
E : 外部引導內部洩油  
EXTERNAL PILOT INTERNAL DRAIN  
T : 內部引導外部洩油  
INTERNAL PILOT EXTERNAL DRAIN

主軸型式，見C08-03頁

SPOOL TYPE (AS C08-03)

閥芯復位 SPOOL RETURN

無代號：彈簧 NO CODE: BY MEANS OF SPRING  
H : 液壓 HYDRAULIC

閥規格 VALVE SIZE

16 : 16mm 25 : 25mm 32 : 32mm

操作方式 TYPES OF OPERATION

WEH : 電液 ELECTRO-HYDRAULIC  
WH : 液壓 HYDRAULIC

工作數量 NUMBER OF MAIN PORTS

4 : 四個工作口 4 MAIN PORTS

最高使用壓力 MAX. OPERATING PRESSURE

H : 350 kgf/cm<sup>2</sup>

- WEH型方向閥是帶電一液操作的方向滑閥，用以控制液流的開啟、停止和方向。
- 此類閥組成主要包括閥體(1)、控制閥芯(2)和一個或二個復位彈簧(3.1)和(3.2)的主閥及帶一個或二個電磁"a"(5.1)·電磁閥"b"(5.2)的先導閥(4)。
- 主閥閥芯(2)由彈簧或壓力保持在中位或初始位置。
- 在彈簧對中的閥中，兩個彈簧腔(6)和(8)通過處於初始位置的先導閥與油箱連通。經過控制油路(7)向先導閥(4)供油。控制油可以由內部或外部供給(外部供給經油口X)。
- 主閥閥芯(2)由先導閥(4)液壓操作。
- 當先導閥操作，施壓於主閥芯的一端，移動閥芯至操作位置。根據操作方向，閥開啟，液流由P至A和B至T或P至B和A至T。
- 當電磁鐵斷電，先導閥復位至靜態位置(脈沖閥除外、彈簧的油箱卸荷。控制油從彈簧腔經先導閥排入Y口)。
- 控制油可內部或外部泄油(外部經油口Y)。
- 可選的手動應急操作器(9)，在電磁鐵不通電情況下，可對先導閥(4)中的控制閥芯(10)進行操作。
- Valves of type WEH are derirectional spool valves with electrohydraulic operation.
- They control the start, stop and derirection of a fluid flow.
- The directional valves basically consist of the main valve with housing (1), main control spool (2), one or two return springs (3.1)and (3.2) and the pilot valve (4) with one or two solenoids "a" (5.1) and for"b" (5.2).
- The main control spool (2) in the main valve is held in the neutral or in the initial position either by the springs or by means of pressure.
- In the initial position, the two spring chambers(6) and (8) are connected to the tank without pressure via the pilot valve (4). The pilot valve is supplied with pilot fluid via the pilot line (7). The pilot oil supply can be either internal or external (external via port X). When the pilot valve is operated, e.g. solenoid "a", the pilot spool (10) is shifted to the left and thus spring chamber (8) is pressurised with pilot pressure. Spring chamber (6) remains unpressurised.
- The pilot pressure acts on the left side of the main control spool (2) and pushes it against the spring (3.1). As a consequence, the ports P to B and A to T are connected in the main valve. When the solenoid is de-energised, the pilot spool returns to its initial position (exception: detented spool). The spring chamber (8) is unloaded to tank. The pilot oil is expelled from the spring chamber via the pilot valve into the Y channel. The pilot oil supply and drain are internal or external (external via port Y). An optional manual override (9) permits pilot spool (10) to be operated without energising the solenoid.

## 剖面圖

## SECTION

型號：4WEH  
TYPE:4WEH

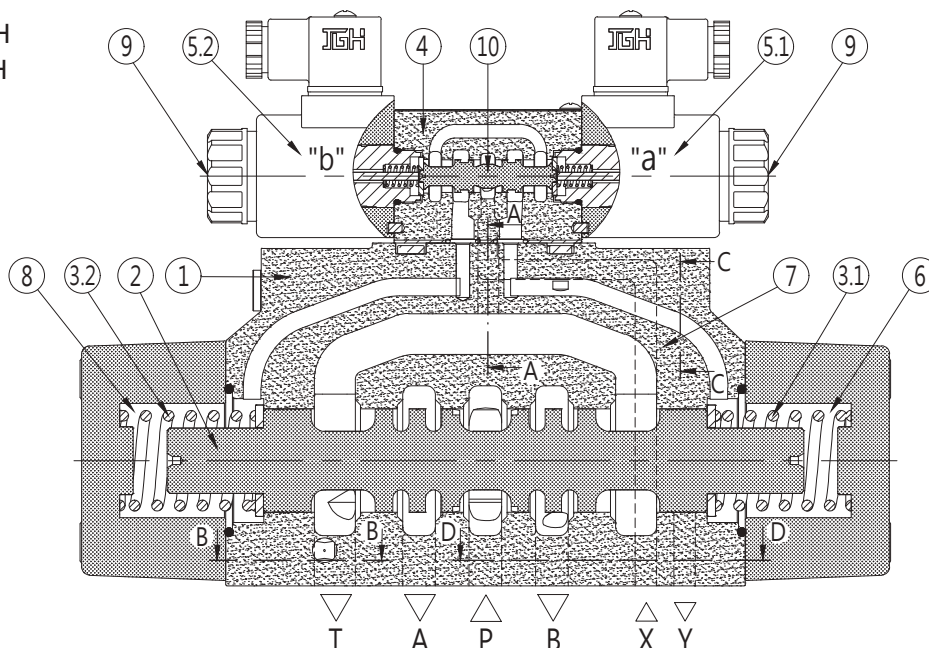



## 規格16 Size 16

剖面圖 D-D  
Section D-D

剖面圖 C-C  
Section C-C

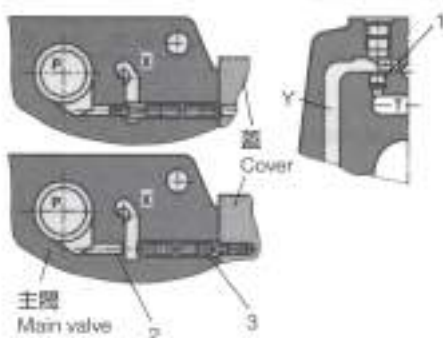

**控制油供給**  
外部：2堵死  
內部：2打開

**Pilot oil supply**  
external : 2 plugged  
internal : 2 open

**控制油洩油**  
外部：1堵死  
內部：1打開

**Pilot oil drain**  
external : 1 plugged  
internal : 1 open

## 規格25 Size 25

剖面圖 B-B  
Section B-B

剖面圖 A-A  
Section A-A

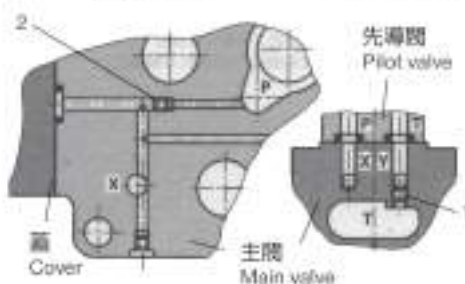

**控制油供給**  
外部：2堵死  
內部：2打開

**Pilot oil supply**  
external : 2 plugged  
internal : 2 open

**控制油洩油**  
外部：1堵死  
內部：1打開

**Pilot oil drain**  
external : 1 plugged  
internal : 1 open

## 規格32 Size 32

剖面圖 A-A  
Section A-A

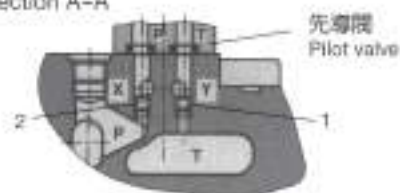

**控制油供給**  
外部：2堵死  
內部：2打開

**Pilot oil supply**  
external : 2 plugged  
internal : 2 open

**控制油洩油**  
外部：1堵死  
內部：1打開

**Pilot oil drain**  
external : 1 plugged  
internal : 1 open

### 控制油供給

### PILOT OIL SUPPLY

#### 4WEH... 和 4WE...ET

控制油供給從單獨的回路經油口X由外部提供。  
控制油洩油經油口Y由外部引回油箱。

#### 4WEH...T...

控制油供給從主閥經油口P由內部提供。  
控制油洩油經油口Y由外部流回油箱。底板中油口X堵死。  
由內控至外控或由外控至內控轉換 ( 規格16 ) : 拆下電磁鐵側端蓋, 拔下插塞, 兩端換位。插入插塞, 把端蓋復位。

#### 4WEH...

控制油供給從主閥經油口P由內部提供。  
控制油洩油經油口T由內部流回油箱。底板中油口X和Y堵死。

#### 4WEH...E...

控制油供給從單獨的回路經油口X由外部提供。  
控制油洩油經油口T由內部流回油箱。底板中油口Y堵死。  
元件1螺紋堵, M6 DIN 906-8.8.3 對邊寬。  
元件2螺紋堵, M6 DIN 906-8.8.3 對邊寬。  
端蓋固定螺釘安裝扭矩: 規格16 : 31~38N·m  
規格25 : 60~74N·m  
先導閥固定螺釘安裝扭矩: 規格16至32 : 8~9N·m

#### 插裝式節流塞

如果先導閥P口控制油流量必須加以限制, 需採用插裝式節流塞。  
插裝式節流塞安裝在先導閥P口。

#### 4WEH... and 4WH...ET

The pilot oil supply is sourced externally via channel X from a separate circuit.  
The pilot oil drain is led externally via channel Y to tank.

#### 4WEH...T...

The pilot oil supply is sourced internally from channel P of the main valve.  
The pilot oil drain is led externally via channel Y to tank. Port X in the subplate is plugged.  
Changeover from external to internal or from internal to external pilot oil supply ( size 16 ) : Remove the cover on the solenoid side "a", remove the plugs and tum end-for-end, insert plugs and replace the cover.

#### 4WEH...

The pilot oil supply is sourced internally from channel P of the main valve.  
The pilot oil drain is led internally via channel T to tank. Ports X and Y in the subplate are plugged.

#### 4WE...E

The pilot oil supply is sourced externally via channel X from a separate circuit. The pilot oil drain is led internally via channel T to tank. Port Y in the subplate is plugged.

- 1.Plug Screw M6 DIN 906-8.8.3 A/F-Pilot oil drain
- 2.Plug Screw M6 DIN 906-8.8.3 A/E-Pilot oil supply
- 3.Plug Screw M8x1 DIN 906-8.8.4 A/F-

Mounting torque for cover fixing screws: Size 16 : 31~38N·m  
Size 25 : 60~74N·m

Mounting torque for pilot valve fixing screws: Size 16 to 32 : 8~9N·m

#### Throttle Insert

The use of a throttle insert is required if the pilot oil supply in the P channel of the pilot valve is to be limited.  
This throttle is inserted in the P channel of the pilot valve.

## 二位閥的詳細與簡化符號 Symbols for valves with 2 spool positions (按DIN ISO 1219)

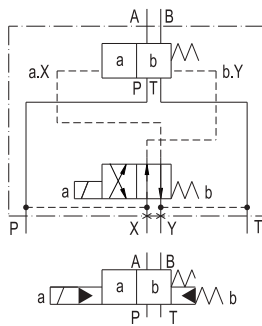
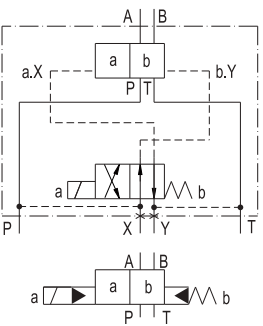
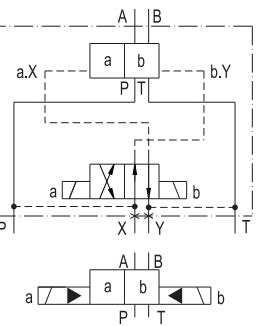
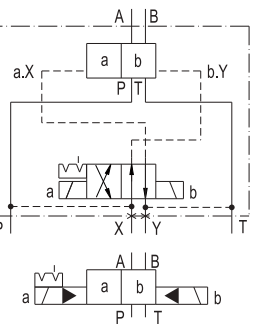
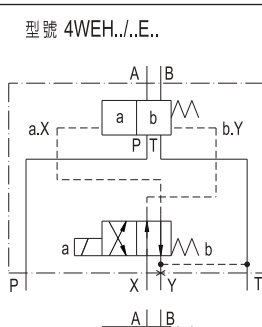
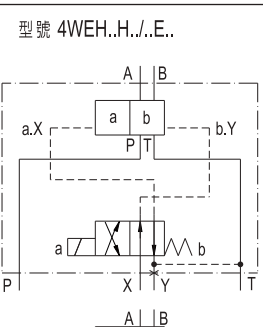
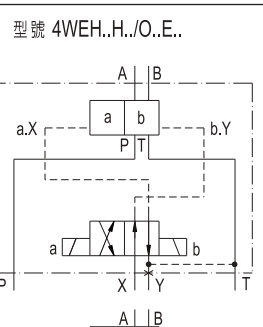
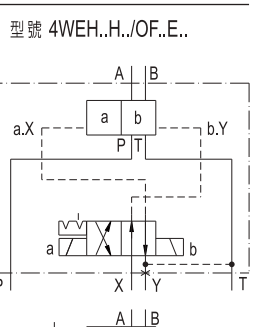
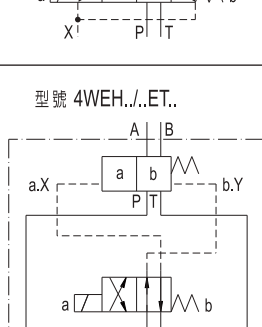
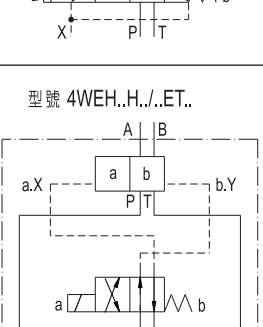
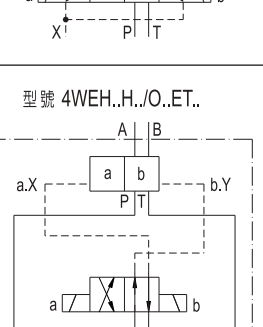
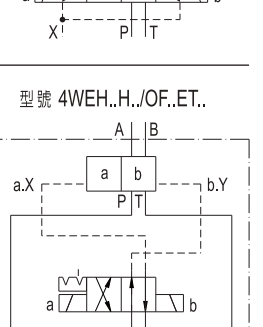
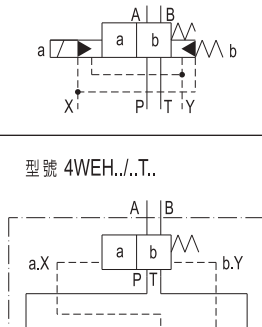
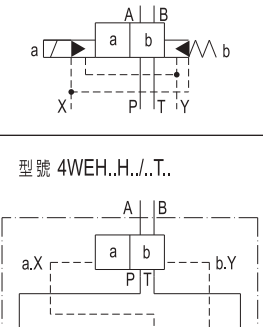
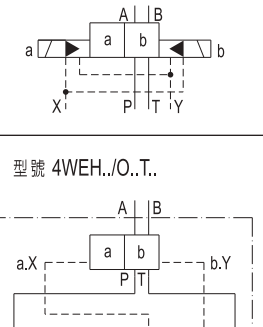
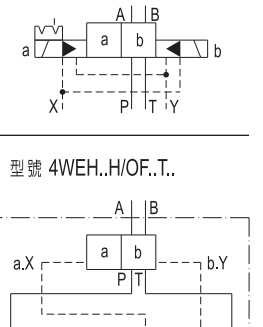
彈簧復位閥 Valve with spring end position		液壓復位閥 Valve with hydraulic end position			
X : 內部 ; Y : 內部 X : internal ; Y : internal	型號 4WEH../.. 	型號 4WEH../..H../.. 	型號 4WEH../..H../..O../.. 	型號 4WEH../..H../..OF../.. 	
	型號 4WEH../..E../.. 	型號 4WEH../..H../..E../.. 	型號 4WEH../..H../..O../..E../.. 	型號 4WEH../..H../..OF../..E../.. 	
	型號 4WEH../..ET../.. 	型號 4WEH../..H../..ET../.. 	型號 4WEH../..H../..O../..ET../.. 	型號 4WEH../..H../..OF../..ET../.. 	
	型號 4WEH../..T../.. 	型號 4WEH../..H../..T../.. 	型號 4WEH../..O../..T../.. 	型號 4WEH../..H../..OF../..T../.. 	
X : 外部 ; Y : 外部 X : external ; Y : external	X : 外部 ; Y : 外部 X : external ; Y : external	X : 外部 ; Y : 外部 X : external ; Y : external	X : 外部 ; Y : 外部 X : external ; Y : external	X : 外部 ; Y : 外部 X : external ; Y : external	



### 三位閥的詳細與簡化符號 Symbols for valves with 3 spool positions (按DIN ISO 1219)

彈簧對中閥  
Valve with spring-centered zero position

壓力對中閥 (僅規格16, 25 ("W.H 25") 和 32)  
Valve with pressure-centered zero position  
[Only NG16, 25 ("W.H 25") and 32]

X : 內部 ; Y : 內部  
X : internal ; Y : internal

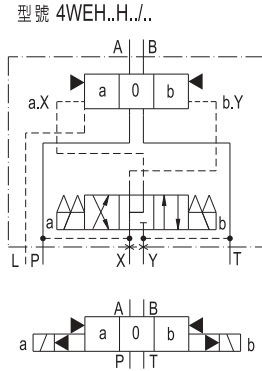
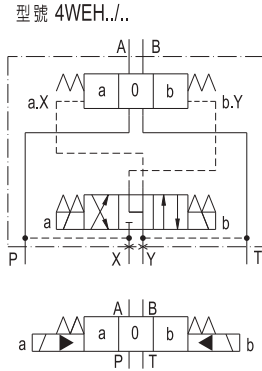

X : 外部 ; Y : 內部  
X : external ; Y : internal

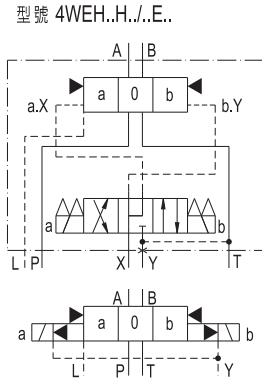
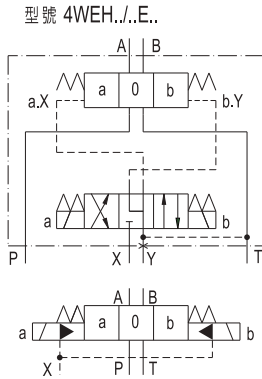

X : 外部 ; Y : 外部  
X : external ; Y : external

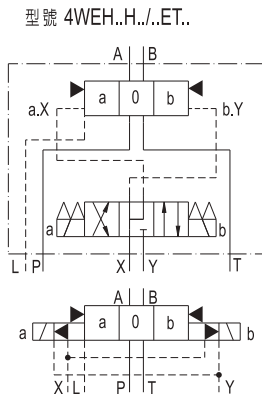
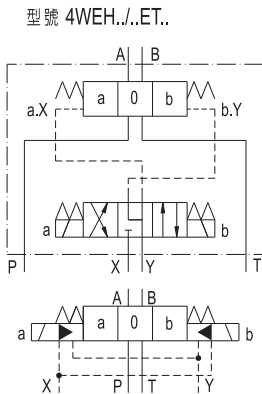

X : 內部 ; Y : 外部  
X : internal ; Y : external

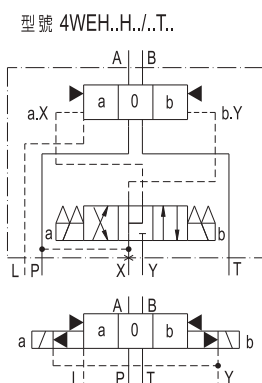
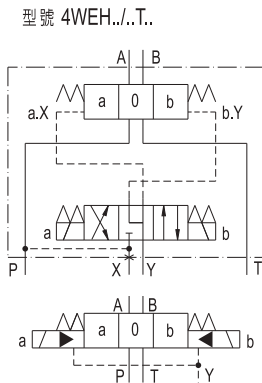

**技術參數**
**TECHNICAL DATA**

規格 ( 訂貨型號 ) Sizes (ordering code)	16	25	32	
最高公稱壓力 Operating pressure, max. - 油口P、A、B - Port P、A、B	4WEH型 Type 4WEH kgf/cm <sup>2</sup>	280	280	280
	H-4WEH型 Type H-4WEH kgf/cm <sup>2</sup>	350	350	350
外部Y口控制油泄油 Pilot oil drain Y external	kgf/cm <sup>2</sup>		250	250
內部Y口控制油泄油 Pilot oil drain Y external	kgf/cm <sup>2</sup>		160 / 210 DC 100 / 160 AC	
外部控制油泄油 - 直流電磁鐵 DC	kgf/cm <sup>2</sup>	160 / 210		
- 交流電磁鐵 AC	kgf/cm <sup>2</sup>	100 / 160		
用於4WH型 with version 4WH	kgf/cm <sup>2</sup>	250	250	250
最高控制壓力 ( 對於高的控制壓力 · 需要一個壓力比閥 ) Pilot pressure, max. (With higher pilot pressures, a pressure reducing valve is required.)	kgf/cm <sup>2</sup>	250	250	250
最低控制壓力 - 外部X口控制油供給 · 內給X口控制油供給 ( 不用於閥芯 : C, F, G, H, P, T, V, Z, S ) Pilot pressure, min. Pilot oil supply X external, pilot oil supply X internal (not with spools: C, F, G, H, P, T, V, Z, S)				
彈簧對中三位閥 3-osition valve, spring-centred	kgf/cm <sup>2</sup>	12	13	8.5
壓力對中三位閥 3-osition valve, pressure-centred	kgf/cm <sup>2</sup>	12	18	8.5
彈簧復位二位閥 2-osition valve, with spring offset	kgf/cm <sup>2</sup>	12	13	10
液壓復位二位閥 2-osition valve, with hydraulic offset	kgf/cm <sup>2</sup>	12	8	5
	kgf/cm <sup>2</sup>	4.5	4.5	4.5
<ol style="list-style-type: none"> <li>1) 在三位閥中 · 壓力對中可能的條件 : <math>P_{Pilot} \approx 2 \times P_{Tank} + P_{Pilot min.}</math></li> <li>2) 閥芯S僅用於規格16</li> <li>3) 對閥芯C, F, G, H, P, T, V, Z, · 如果在中位由P至T ( 三位閥 ) 或當閥經中位 ( 二位閥 ) 運動時 · 流量足夠確保由P至T的壓降為6.5 bar · 才能用內部控制油供給 ·</li> <li>4) 對閥芯C, F, G, H, P, T, V, Z, S2) ( 借助於預載閥或足夠大的流量 )</li> <li>5) 高性能閥"6E" (RC 23 178)</li> </ol>	<ol style="list-style-type: none"> <li>1) As 3-position valve with spring-entring only possible if <math>P_{Pilot} \approx 2 \times P_{Tank} + P_{Pilot min.}</math></li> <li>2) Spool S only for size 16</li> <li>3) For symbols C, F, G, H, P, T, V, Z internal pilot oil supply is only possible, if the flow from P to T in the neutral position (in a 3-position valve ) or when the valve is moving through the neutral position (in a 2-position valve) is large enough to ensure a min. pressure differential of 6.5 bar from P to T</li> <li>4) For spools C, F, G, H, P, T, V, Z, S2) (by means of a preload valve or a sufficiently large flow)</li> <li>5) High-Performance valve "6E" (RE 23 178)</li> </ol>			

液壓油 Hydraulic fluid 1) 適用於丁腈橡膠密封和氟橡膠密封圈 Suitable for NBR and FPM seals 2) 只用於氟橡膠密封 Only suitable for FPM seals	礦物油 (HL, HLP) 按 DIN 51524 ; 快速生物降解油液按 VDMA 24 568 HETG (菜籽油) ; HEPS (聚乙二醇) ; HEES (合成酯) ; 其他油液按要 Mineral oil ( HL, HLP ) to DIN 51 524 ; Fast bio-egradable hydraulic fluids to VDMA 24 568 HETG ( rape seed oil ) ; HEPG ( polyglycols ) ; HEES ( synthetic esters ) ; other hydraulic fluids on enquiry						
油液 Pressure fluid	$t$	$^{\circ}\text{C}$	-30至+80 ( 帶丁腈橡膠密封 ) -30 to +80 ( for NBR seals )				
溫度變化範圍 Temperature range			-20至+80 ( 帶氟橡膠密封 ) -20 to +80 ( for FPM seals )				
粘度範圍 Viscosity range	$\nu$	$\text{mm}^2/\text{s}$	28至500 28 to 500				
油液清潔度 Degree of fluid contamination	油液最高污染等級按NAS 1638第9級。 因而我們推薦過濾器最小過濾精度 $\beta_{10} \geq 75$ 。 Maximum permissible degree of contamination of the hydraulic fluid to NAS 1638 class 9. We therefore recommend a filter with a minimum retention rate of $\beta_{10} \geq 75$ .						
用於閥操作的控制油容量 Pilot oil volume for shifting operation							
- 三位閥彈簧對中 - 3-position valve, spring-centred	$\text{cm}^3$	5.72	14.2		29.4		
- 二位閥 - 2-position valve	$\text{cm}^3$	11.45	28.4		58.8		
- 三位閥 · 液壓對中 - 3-position valve, pressure-centred	$\text{cm}^3$	WH	WEH	WH	WEH	WH	
從中位至位置a from neutral position to shifted position "a"	$\text{cm}^3$	2.83	2.83	7.15	7.15	14.4	14.4
從位置a至中位 from shifted position "a" to neutral position	$\text{cm}^3$	2.9	5.73	14.18	7.0	29.4	15.1
從中位至位置b from neutral position to shifted position "b"	$\text{cm}^3$	5.72	5.73	14.18	14.15	29.4	29.4
從位置b至中位 from shifted position "b" to neutral position	$\text{cm}^3$	2.83	8.55	19.88	5.73	43.8	14.4
用於更短操作時間的控制油流量 Pilot oil flow for shortest shifting time		大約35 approx. 35	大約35 approx. 35		大約35 approx. 35		
重量 Weight	單電磁鐵閥 Valve with one solenoid	$\text{kg}$	大約8.3 approx. 8.3	大約17.6 approx. 17.6		大約40.5 approx. 40.5	
	雙電磁鐵閥 · 彈簧對中 Valve with two solenoids, spring-centred	$\text{kg}$	大約8.6 approx. 8.6	大約18.0 approx. 18.0		大約41.0 approx. 41.0	
	雙電磁鐵閥 · 液壓對中 Valve with two solenoid, pressure-centred	$\text{kg}$	大約8.6 approx. 8.6	大約19.0 approx. 19.0		大約41.0 approx. 41.0	
	液控閥 Valve with hydraulic operation (4 WH...)	$\text{kg}$	大約7.3 approx. 7.3	大約16.5 approx. 16.5		大約39.5 approx. 39.5	
	液控阻尼調整 Shifting time adjustment	$\text{kg}$	大約0.8 approx. 0.8	大約0.8 approx. 0.8		大約0.8 approx. 0.8	
	壓力比閥 Pressure reducing valve	$\text{kg}$	大約0.4 approx. 0.4	大約0.4 approx. 0.4		大約0.4 approx. 0.4	
安裝位置 Installation position	可選擇：液壓復位閥"H" · (閥芯C, D, K, Z, Y)水平 Optional: valve with hydraulic spool return "H" (spools C, D, K, Z, Y) horizontal						



操作時期 <sup>1)</sup> Shifting times <sup>1)</sup>														
1) 操作時間=從電磁鐵通電到主閥芯的控制台肩開啟的時間。 1) Shifting time = Contacting at the pilot valve up to start of opening of the control land in the main valve														
規格 16 (先導閥6X系列E) Size 16 (Pilot valve series 6X/E)	閥從中位至操作位置的操作時間 (用於直流 (DC) 和交流 (AC) 操作) Shifting time of the valve from neutral position to shifted position with AC and DC operation													
	在控制壓力下 at pilot pressure	kgf/cm <sup>2</sup>	AC 50 DC		AC 150 DC		AC 250 DC							
	- 三位閥 · 彈簧對中 - 3-position valve, spring-centred	ms	35	65	30	60	30	58						
	- 二位閥 - 2-position valve	ms	45	65	35	55	30	50						
	- 三位閥 - 3-position valve	電磁鐵操作 Solenoid operated	a	b	a	b	a	b	a	b	a	b	a	b
	壓力對中 pressure-centred	ms	30	30	65	65	25	25	55	63	20	25	55	60
	閥從操作位置至中位的操作時間 Shifting time of the valve from shifted position to neutral position													
	- 三位閥 - 3-position valve	ms	30至45用於DC /30用於AC 30 to 45 for DC /30 for AC											
	- 二位閥 - 2-position valve	ms	45...60	45	35...50	35	30...45	30						
	- 三位閥 - 3-position valve	從— From—	a	b	a	b	a	b	a	b	a	b	a	b
壓力對中 pressure-centred	ms	20...35	20	20...35	20	20...35	20	20...35	20					
規格 25 (先導閥6X系列E) Size 25 (Pilot valve series 6X/E)	閥從中位至操作位置的操作時間 (用於直流 (DC) 和交流 (AC) 操作) Shifting time of the valve from neutral position to shifted position with AC and DC operation													
	在控制壓力下 at pilot pressure	kgf/cm <sup>2</sup>	AC 70 DC		AC 140 DC		AC 210 DC		AC 250 DC					
	- 三位閥 · 彈簧對中 - 3-position valve, spring-centred	ms	50	85	40	75	35	70	30	65				
	- 二位閥 - 2-position valve	ms	120	160	100	130	85	120	70	105				
	- 三位閥 - 3-position valve	電磁鐵操作 Solenoid operated	a	b	a	b	a	b	a	b	a	b	a	b
	壓力對中 pressure-centred	ms	30	35	55	65	30	35	55	65	25	30	50	60
	閥從操作位置至中位的操作時間 Shifting time of the valve from shifted position to neutral position													
	- 三位閥 · 彈簧對中 - 3-position valve, spring-centred	ms	40至55用於DC /40用於AC 40 to 55 for DC /40 for AC											
	- 二位閥 - 2-position valve	ms	120	125	85	100	85	90	75	80				
	- 三位閥 - 3-position valve	從— From—	a	b	a	b	a	b	a	b	a	b	a	b
壓力對中 pressure-centred	ms	30...50	30	35	30...50	30	35	30...50	30	35	30...50	30	35	

操作時期 <sup>1)</sup> Shifting times <sup>1)</sup>														
1) 操作時間=從電磁鐵通電到主閥芯的控制台肩開啟的時間。 1) Shifting time = Contacting at the pilot valve up to start of opening of the control land in the main valve														
閥從中位至操作位置的操作時間 (用於直流 (DC) 和交流 (AC) 操作) Shifting time of the valve from neutral position to shifted position with AC and DC operation														
規格 32 (先導閥6X系列E) Size 32 (Pilot valve series 6X/E)	在控制壓力下 at pilot pressure	kgf/cm <sup>2</sup>	AC 50		DC		AC 150		DC		AC 250		DC	
	- 三位閥 · 彈簧對中 - 3-position valve, spring-centred	ms	65		80		50		90		35		105	
	- 二位閥 - 2-position valve	ms	100		130		75		100		60		115	
	- 三位閥 - 3-position valve	ms	電磁鐵操作 Solenoid operated											
	壓力對中 pressure-centred		a	b	a	b	a	b	a	b	a	b	a	b
			55	60	100	105	40	45	85	95	35	40	85	95
閥從操作位置至中位的操作時間 Shifting time of the valve from shifted position to neutral position														
	- 三位閥 - 3-position valve	ms	60至75用於DC /50用於AC 60 to 75 for DC /50 for AC											
	- 二位閥 - 2-position valve	ms	115...130		90		85...100		70		65...80		65	
	- 三位閥 - 3-position valve	ms	從— From—											
	壓力對中 pressure-centred		a	b	a	b	a	b	a	b	a	b	a	b
			30...65	30	40	60...90	30	30	105...155	50	50			

特性曲線 (在  $v = 41 \text{ mm}^2/\text{s}$  及  $t = 50^\circ\text{C}$  時測得)

Switching power limits (measured at  $v = 41 \text{ mm}^2/\text{s}$  and  $t = 50^\circ\text{C}$ )

● 4WEH-16...型

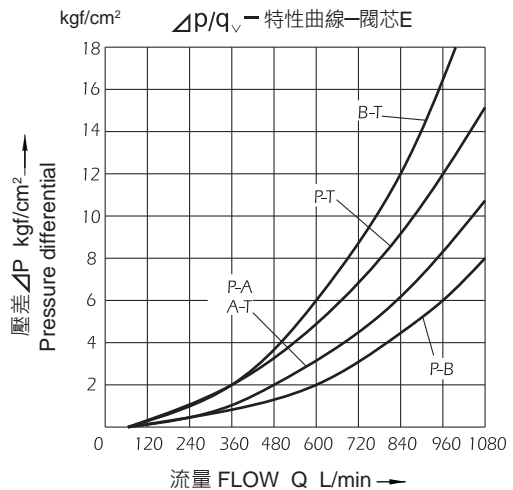
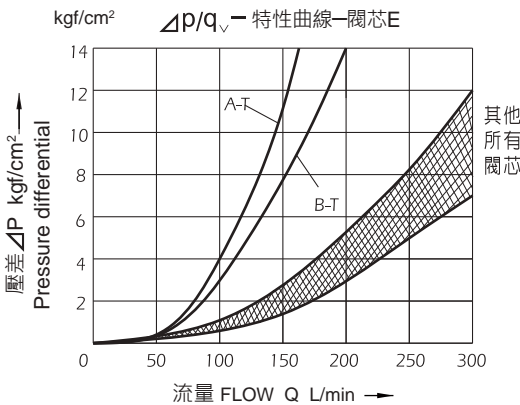
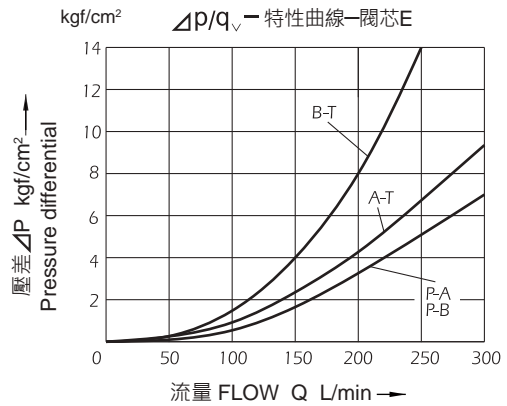
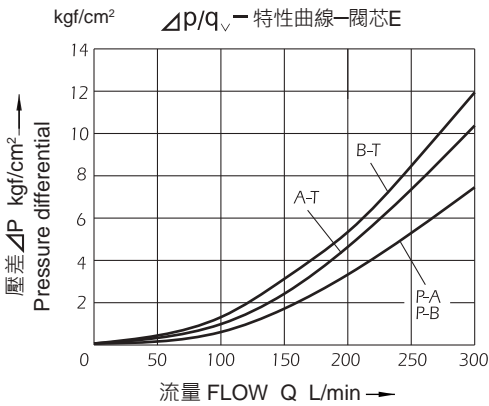

**性能極限：4WEH-16...型 (在  $v = 41 \text{ mm}^2/\text{s}$  及  $t = 50^\circ\text{C}$  時測得)**

**Performance limits: Type 4WEH-16... (measured at  $v = 41 \text{ mm}^2/\text{s}$  and  $t = 50^\circ\text{C}$ )**

二位閥 (允許流量 $q_v \text{ L/min}$ ) 2-position valve (Permissible flow $q_v \text{ L/min}$ )						需帶X內控 預載閥 X = 內控 Pre-load valve, required for X=internal
閥芯 Spool	公稱壓力 $\Delta P \text{ kgf/cm}^2$ Operating pressure $P_{max}$ in $\text{kgf/cm}^2$					
		70	140	210	280	350
主閥彈簧復位 with spring offset in the main valve						
C,D,K,Z,Y	300	300	300	300	300	
主閥彈簧復位 with spring offset in the main valve						閥芯C和Z 大約至 160 L/min Spools C, Z up to approx. 160 L/min
C	300	300	300	300	300	
D,Y	300	270	260	250	230	
K	300	250	240	230	210	
Z	300	260	190	180	160	
主閥液壓復位 with hydraulic offset in the main valve						
HC,HD,HK	300	300	300	300	300	
HZ,HY	300	300	300	300	300	

三位閥 (允許流量 $q_v \text{ L/min}$ ) 3-position valve (Permissible flow $q_v \text{ L/min}$ )						需帶X內控 預載閥 X = 內控 Pre-load valve, required for X=internal
閥芯 Spool	公稱壓力 $\Delta P \text{ kgf/cm}^2$ Operating pressure $P_{max}$ in $\text{kgf/cm}^2$					
		70	140	210	280	350
彈簧對中 spring-centred						
E,H,J,L,M Q,U,W,R	300	300	300	300	300	通常閥芯 F, G, H, P和S Spools F, G, H, P and S in general
C	300	300	300	300	300	
D,Y	300	270	260	250	230	
K	300	250	240	230	210	
Z	300	260	190	180	160	
壓力對中(最低控制壓力 $16 \text{ kgf/cm}^2$ ) Pressure-centred (at min. pilot pressure of $16 \text{ kgf/cm}^2$ )						閥芯大約至 160 L/min Spools V up to approx. 160 L/min
所有閥芯 for all Spools	300	300	300	300	300	

- 1) 當最低控制壓力  $12 \text{ kgf/cm}^2$  存在時，可達到所給流量值。
- 2) 當控制功力降低時，流量值受復位彈簧能使閥復位的流量值的限制。

- 1) The flow valves given are achieved when the minimum pilot pressure of  $12 \text{ kgf/cm}^2$  is present.
- 2) The flow valves given are limiting valves at which the return spring can return the valve when the pilot pressure fails.

**△ 注意！**

當使用一個主閥芯壓力對中的三位四通閥超出所給的性能極限時，要求控制壓力更高。  
因而，如果回路公稱壓力為  $350 \text{ kgf/cm}^2$ ，流量為  $300 \text{ L/min}$ ，則要求控制壓力為  $16 \text{ kgf/cm}^2$ 。  
因而，此閥的最大流量只取決於經過閥的可接受的壓降。

**△ Attention**

When using 4/3-way directional valves with spring-centring of the control spool in the main valve, which exceeds the given performance limits, a higher pilot pressure is required.  
Example: At an operating pressure of  $P_{max} = 350 \text{ kgf/cm}^2$  and a flow of  $q_v = 300 \text{ L/min}$ , a pilot pressure of  $16 \text{ kgf/cm}^2$  is required.

The maximum flow for those valves is therefore only dependent on the  $\Delta P$  valve which is acceptable for the system.

### 特性曲線 (在 $v = 41 \text{ mm}^2/\text{s}$ 及 $t = 50^\circ\text{C}$ 時測得)

### Switching power limits (measured at $v = 41 \text{ mm}^2/\text{s}$ and $t = 50^\circ\text{C}$ )

#### ● 4WEH-25...型

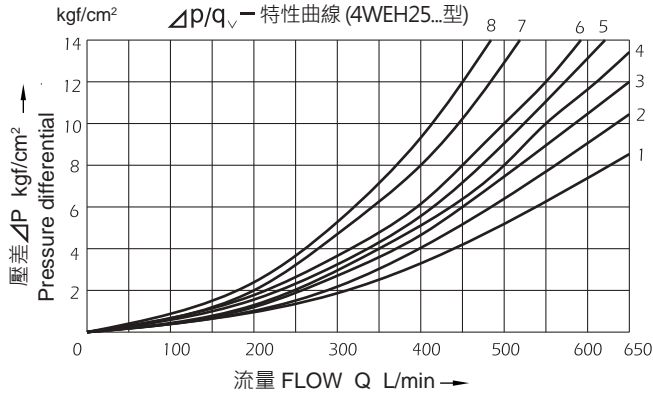

閥芯 Spool	操作位置 Shifted position			
	P→A	P→B	A→T	B→T
E	1	1	1	3
F	1	4	3	3
G	3	1	2	4
H	4	4	3	4
J	2	2	3	5
L	2	2	3	3
M	4	4	1	4
P	4	1	1	5
Q	2	2	3	5
R	2	1	1	-
U	2	1	1	6
V	4	4	3	6
W	1	1	1	3
T	3	1	2	4

### 性能極限：4WEH-25...型 (在 $v = 41 \text{ mm}^2/\text{s}$ 及 $t = 50^\circ\text{C}$ 時測得)

### Performance limits: Type 4WEH-25... (measured at $v = 41 \text{ mm}^2/\text{s}$ and $t = 50^\circ\text{C}$ )

二位閥 (允許流量 $q_v$ L/min) 2-position valve (Permissible flow $q_v$ L/min)					
閥芯 Spool	公稱壓力 $\Delta P$ kgf/cm <sup>2</sup> Operating pressure $P_{max}$ in kgf/cm <sup>2</sup>				
	70	140	210	280	350
需帶X內控預載閥 X = 內控 Pre-load valve, required for X=internal					
主閥彈簧復位 with spring offset in the main valve					
C,D,K,Z,Y	700	700	700	700	650
主閥彈簧復位 with spring offset in the main valve					
C	700	700	700	700	650
D,Y	700	650	400	350	300
K	700	650	420	370	320
Z	700	700	650	480	400
主閥液壓復位 with hydraulic offset in the main valve					
HC,HD,HK	700	700	700	700	700
HZ,HY	700	700	700	700	700
HC./O..	700	700	700	700	700
HD./O..	700	700	700	700	700
HK./O..	700	700	700	700	700
HZ./O..	700	700	700	700	700
HC./OF..	700	700	700	700	700
HD./OF..	700	700	700	700	700
HK./OF..	700	700	700	700	700
HZ./OF..	700	700	700	700	700

三位閥 (允許流量 $q_v$ L/min) 3-position valve (Permissible flow $q_v$ L/min)					
閥芯 Spool	公稱壓力 $\Delta P$ kgf/cm <sup>2</sup> Operating pressure $P_{max}$ in kgf/cm <sup>2</sup>				
	70	140	210	280	350
需帶X內控預載閥 X = 內控 Pre-load valve, required for X=internal					
彈簧對中 spring-centred					
E,L,M Q,U,W	700	700	700	700	650
G,T	400	400	400	400	400
F	650	550	430	330	300
H	700	650	550	400	360
J	700	700	650	600	520
P	650	550	430	330	300
V	650	550	400	350	310
R	700	700	700	650	580
壓力對中(最低控制壓力18 kgf/cm <sup>2</sup> ) Pressure-centred (at min. pilot pressure of 18 kgf/cm <sup>2</sup> )					
E,F,H,J	700	700	700	700	650
L,M,P,Q	700	700	700	700	650
R,U,V,W	700	700	700	700	650
G,T	400	400	400	400	400
在高於30 kgf/cm <sup>2</sup> 時控制壓力 at >30 kgf/cm <sup>2</sup> pilot pressure					
G,T	700	700	700	700	650

- 1) 當最低控制壓力13 kgf/cm<sup>2</sup>存在時，可達到所給流量值。
- 2) 當控制功力降低時，流量值受復位彈簧能使閥復位的流量值的限制。

- 1) The flow valves given are achieved when the minimum pilot pressure of 13 kgf/cm<sup>2</sup> is present.
- 2) The flow valves given are limiting valves at which the return spring can return the valve when the pilot pressure fails.

### 特性曲線 (在 $v = 41 \text{ mm}^2/\text{s}$ 及 $t = 50^\circ\text{C}$ 時測得)

### Switching power limits (measured at $v = 41 \text{ mm}^2/\text{s}$ and $t = 50^\circ\text{C}$ )

#### ● 4WEH-32...型

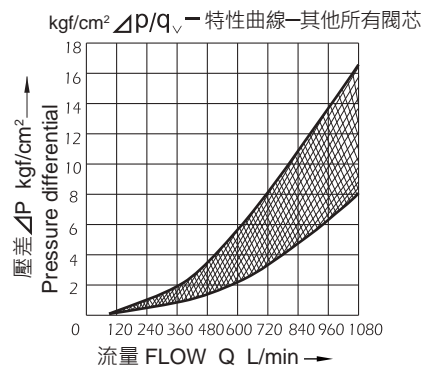
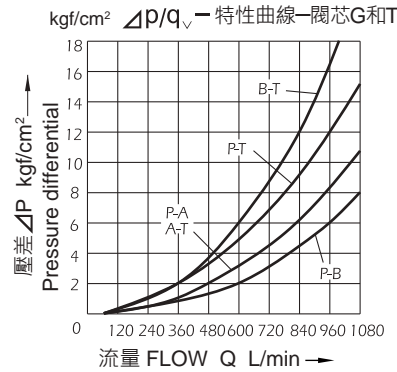
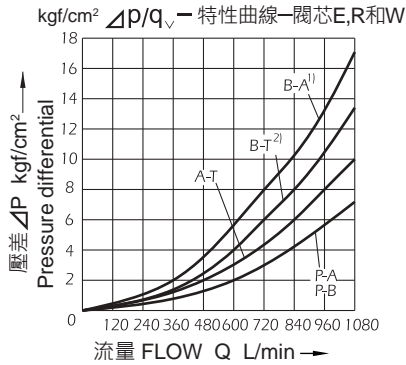

### 性能極限：4WEH-32...型 (在 $v = 41 \text{ mm}^2/\text{s}$ 及 $t = 50^\circ\text{C}$ 時測得)

### Performance limits: Type 4WEH-32... (measured at $v = 41 \text{ mm}^2/\text{s}$ and $t = 50^\circ\text{C}$ )

二位閥 (允許流量 $q_v$ L/min) 2-position valve (Permissible flow $q_v$ L/min)						需帶X內控 預載閥 X = 內控 Pre-load valve, required for X=internal
閥芯 Spool	公稱壓力 $\Delta P$ kgf/cm <sup>2</sup> Operating pressure $P_{max}$ in kgf/cm <sup>2</sup>					
	70	140	210	280	350	
主閥彈簧復位 with spring offset in the main valve						閥芯C和Z 大約至 160 L/min Spools C, Z up to approx. 160 L/min
C,D,K,Z,Y	1100	1040	800	750	680	
主閥彈簧復位 with spring offset in the main valve						
C	1100	1040	860	800	700	
D,Y	1100	1040	540	480	420	
K	1100	1040	860	500	450	
Z	1100	1040	860	700	650	
主閥液壓復位 with hydraulic offset in the main valve						閥芯HC和HZ 大約至 180 L/min Spools HC, HZ up to approx. 180 L/min
HC,HD,HK	1100	1040	860	750	680	
HZ,HY	1100	1040	860	750	680	

三位閥 (允許流量 $q_v$ L/min) 3-position valve (Permissible flow $q_v$ L/min)						需帶X內控 預載閥 X = 內控 Pre-load valve, required for X=internal
閥芯 Spool	公稱壓力 $\Delta P$ kgf/cm <sup>2</sup> Operating pressure $P_{max}$ in kgf/cm <sup>2</sup>					
	70	140	210	280	350	
彈簧對中 spring-centred						通常閥芯 F, G, H, P和T 閥芯V大約至 180 L/min Spools F, G, H, P and T in general, Spool V up to approx. 180 L/min
E,J,L,M Q,R,U,W	1100	1040	860	750	680	
G,T,H,F,P	900	900	800	650	450	
V	1100	1000	680	500	450	
壓力對中(最低控制壓力8.5 kgf/cm <sup>2</sup> ) Pressure-centred (at min. pilot pressure of 8.5 kgf/cm <sup>2</sup> )						
所有閥芯 for all Spools	1100	1040	860	750	680	

#### △ 注意！

當使用一個主閥芯壓力對中的三位四通閥超出所給的性能極限時，要求控制壓力更高。

因而，如果回路公稱壓力為  $P_{max} = 350 \text{ kgf/cm}^2$ ，流量為  $q_v = 1100 \text{ L/min}$ ，則要求控制壓力為  $15 \text{ kgf/cm}^2$ 。

因而，此閥的最大流量只取決於經過閥的可接受的壓降。

#### △ Attention

When using 4/3-way directional valves with spring-centring of the control spool in the main valve, which exceeds the given performance limits, a higher pilot pressure is required.

Example: At an operating pressure of  $P_{max} = 350 \text{ kgf/cm}^2$  and a flow of  $q_v = 1100 \text{ L/min}$ , a pilot pressure of  $15 \text{ kgf/cm}^2$  is required.

The maximum flow for those valves is therefore only dependent on the  $\Delta P$  valve which is acceptable for the system.

- 1) 當最低控制壓力  $10 \text{ kgf/cm}^2$  存在時，可達到所給流量值。
- 2) 當控制功力降低時，流量值受復位彈簧能使閥復位的流量值的限制。
- 1) The flow valves given are achieved when the minimum pilot pressure of  $10 \text{ kgf/cm}^2$  is present.
- 2) The flow valves given are limiting valves at which the return spring can return the valve when the pilot pressure fails.

單位 UNIT : mm

### 安裝尺寸 INSTALLATION DIMENSIONS

## H-4WEH-16

通用底板尺寸  
 APPLICATIVE SUB-PLATE DIMENSIONS  
**MC - 04 - 1**  
 (詳見 E01-10 Page E01-10)

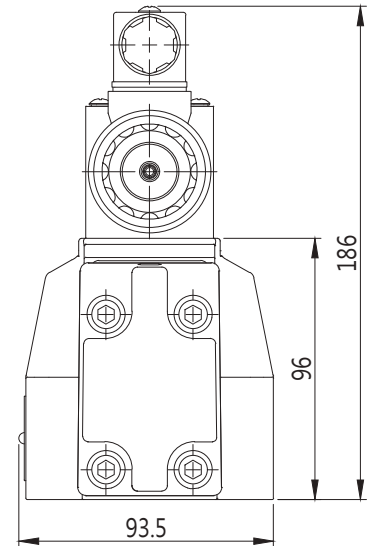
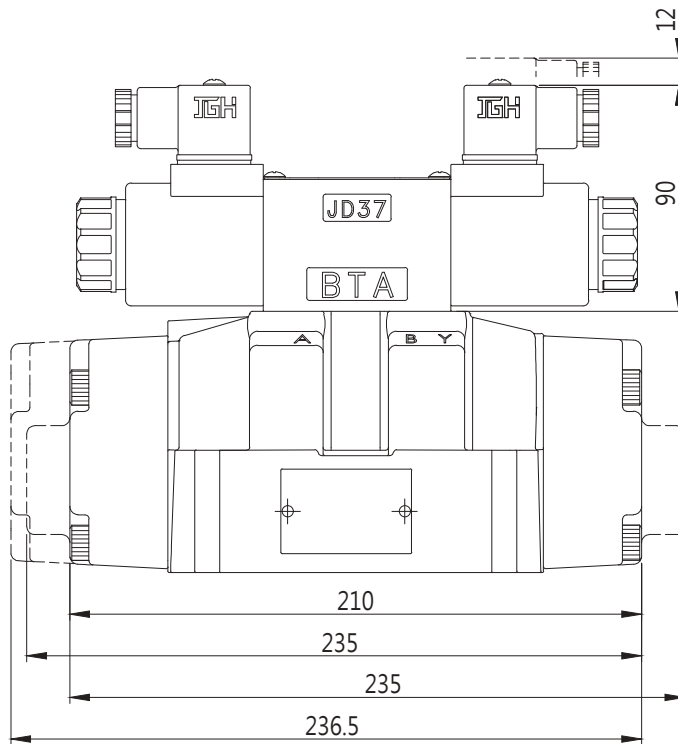
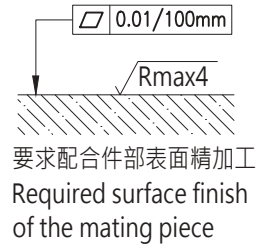
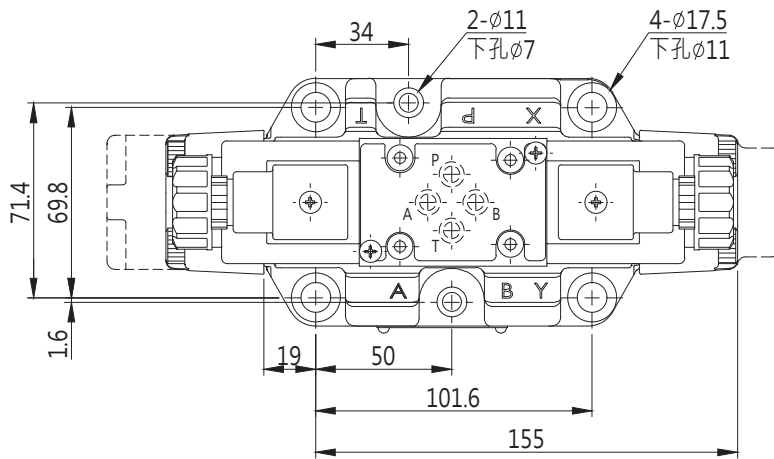

閥固定螺釘

4個M10x60L DIN 912-12.9 · 安裝扭矩 60~74N·m  
 2個M6x50L DIN 912-12.9 · 安裝扭矩 12~15N·m

Valve fixing screws

4 off M10x60L DIN 912-12.9, Mounting torque 60~74N·m  
 2 off M6x50L DIN 912-12.9, Mounting torque 12~15N·m

單位 UNIT : mm

安裝尺寸

INSTALLATION DIMENSIONS

H-4WEH-25

通用底板尺寸  
 APPLICATIVE SUB-PLATE DIMENSIONS  
**MC - 04 - 2**  
 (詳見 E01-10 Page E01-10)

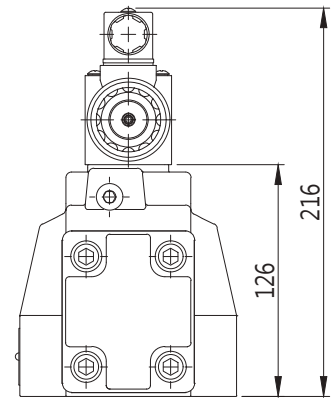
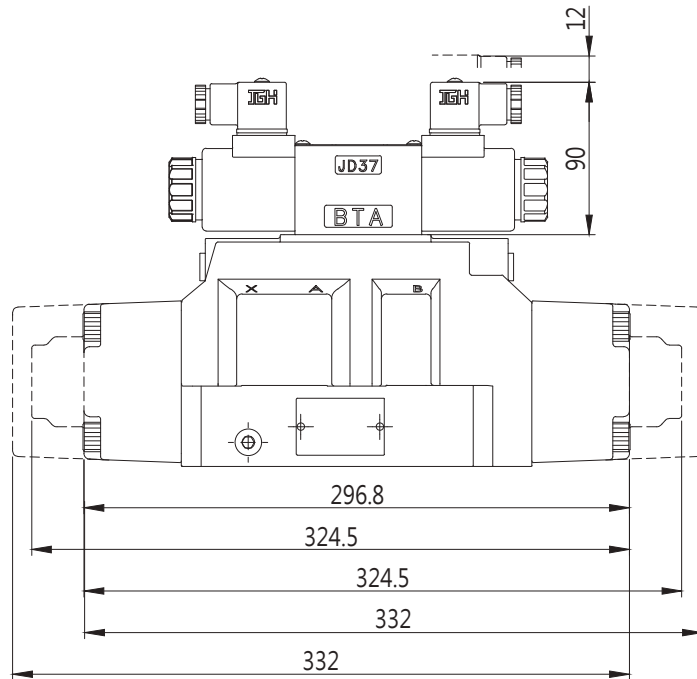
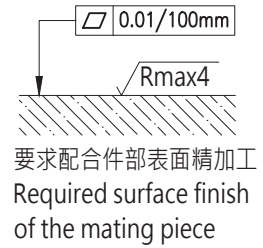
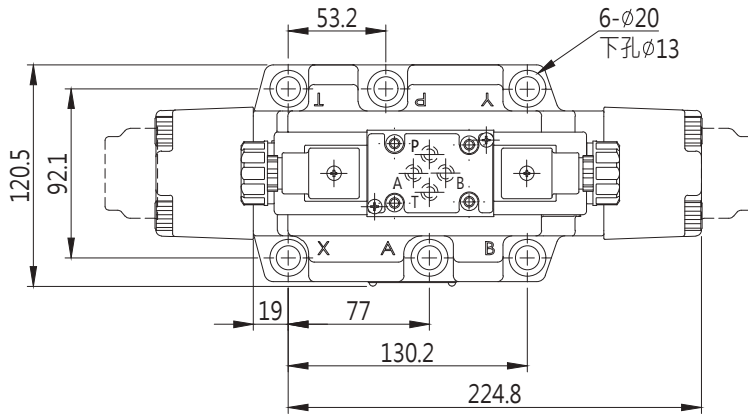

閥固定螺釘

6個M12x60L DIN 912-12.9 · 安裝扭矩 104~127N·m

Valve fixing screws

6 off M12x60L DIN 912-12.9, Mounting torque 104~127N·m

單位 UNIT : mm

### 安裝尺寸 INSTALLATION DIMENSIONS

## H-4WEH-32

通用底板尺寸  
 APPLICATIVE SUB-PLATE DIMENSIONS  
**MC - 04 - 3**  
 (詳見 E01-11 Page E01-11)

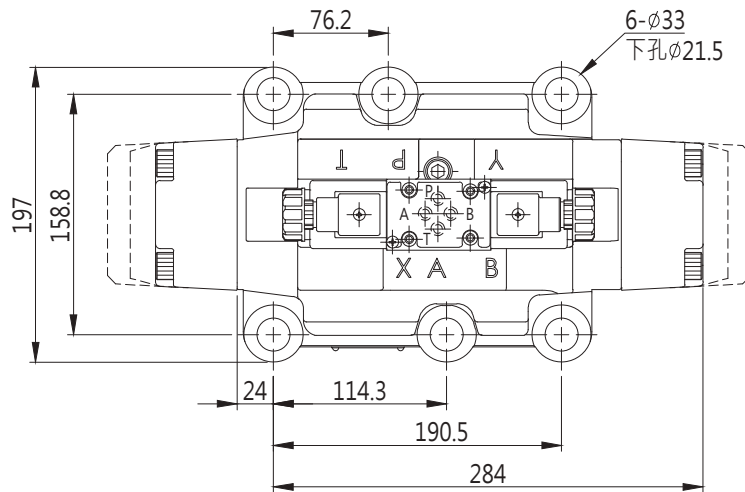

0.01/100mm

Rmax4

要求配合件部表面精加工  
 Required surface finish  
 of the mating piece

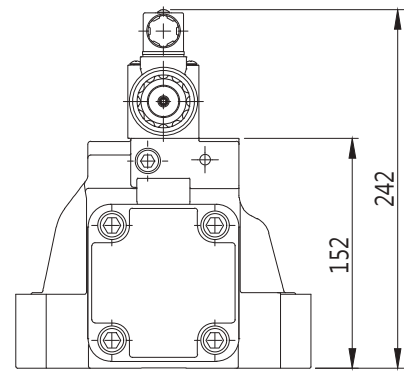
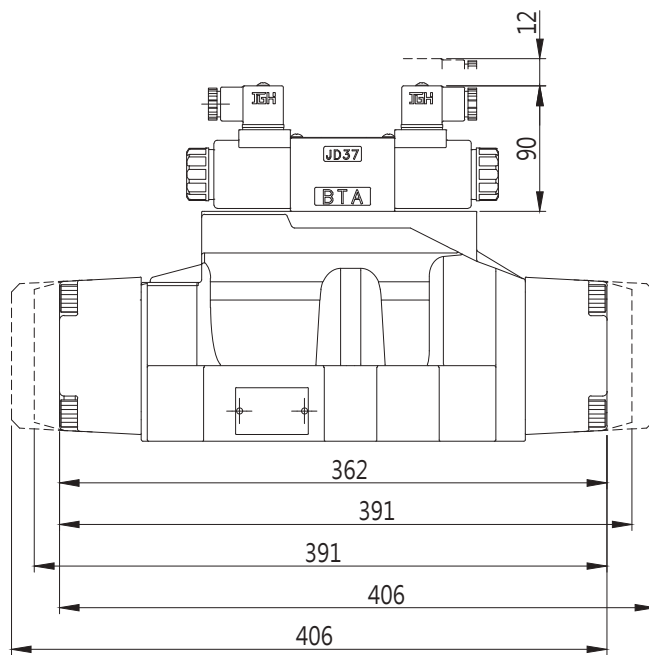

閥固定螺釘

6個M20x80L DIN 912-12.9 · 安裝扭矩 493~603N·m

Valve fixing screws

6 off M20x80L DIN 912-12.9, Mounting torque 493~603N·m